

# CENTRIFUGAL **BLOWERS** & FANS

ISO 9001 : 2015 Certified COMPANY



**MITTAL BLOWERS INDIA PVT. LTD.**

# CERTIFICATE

## CERTIFICATE



Management system as per  
ISO 9001 : 2015

In accordance with TÜV INDIA procedures, it is hereby certified that

**MITTAL BLOWERS INDIA PVT. LTD.**  
Plot No. C/17 Krishna Industrial Park - 2,  
Near Royal Estate, Opp. Lake Shivbhumi Estate Road,  
Kubadthal, Tal. Daskroi, Ahmedabad - 382 430,  
Gujarat,  
India

applies a management system in line with the above standard for the following scope

**Design, Manufacture and Supply of Industrial Blowers, Fans and  
Air Pollution Control Equipments**

Certificate Registration No. **GM 02 01351**  
Audit Report No. **Q 94672019**

Valid until: **01.04.2022**

Certification Body  
at TÜV INDIA PVT. LTD.

Issue: **02.04.2019**  
Place: **Mumbai**

This certification was conducted in accordance with the TÜV INDIA auditing and certification procedures & shall be valid subject to regular Surveillance Audits.

TÜV India Pvt. Ltd., 901, Naraya Plaza - 1, L.B.S. Marg, Chakrapur (W), Mumbai - 400 096, India [cert.tuvindia.com](http://cert.tuvindia.com)

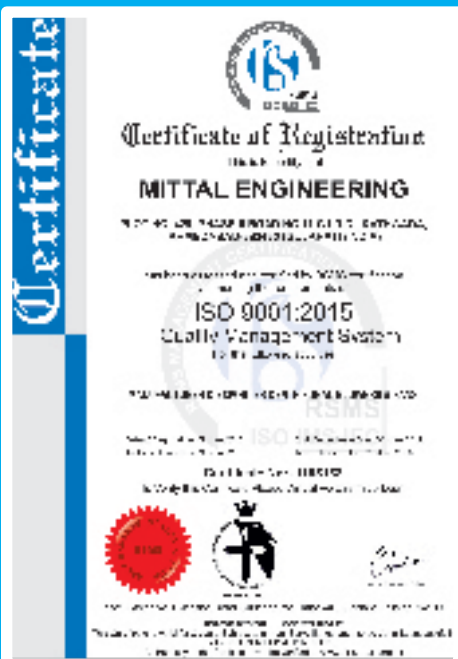

# Company Profile

**MITTAL BLOWERS INDIA PVT. LTD.** (Formerly known as Mittal Engineering) is one of the leading manufacturer of Blowers, Fans and Air pollution control equipments. We are TUV NORD certified ISO 9001:2015.

MITTAL BLOWERS INDIA PVT. LTD. is an independent designer and manufacturer of Industrial Blowers, Fans and Air pollution control equipments. Our thousands of fans in operation in India and other countries. We have good response as well as satisfying results.

MITTAL BLOWERS INDIA PVT. LTD. (Formerly known as Mittal Engineering) was established in the year 2005 by a group of experienced technocrat on a small scale under the able guidance of Mr. Mahesh Panchal. Since then our endeavour is to strive continually to offer product innovation and quality. We offer cost effective products which are not only efficient but also required minimum maintenance.

We maintain strict quality procedure in design, manufacturing and testing. The centrifugal fan is the heart of any system. If the fan does not deliver required pressure and volume, the system will not work efficiently and operating cost of the plant will increase. We design and manufacture fans for wide range of pressure, volume and power to suit customer requirement. Many blowers of several capacities are available in various specifications. However, We specializes in offering tailor made designs as well to suit customer specifications.

**OUR BUSINESS PHILOSOPHY** "To completely satisfy the customer's demands with quality, time bound commitments and best prices in industry, using our expertise in the field of engineering with proven standards."

**QUALITY AN INTEGRAL PART** "Quality has been our prime importance and this aspect has given us an edge over others in the industry. To ensure high quality levels we have developed a separate section fully equipped with advance testing equipment and machinery. We conduct specific test on each and every product so that our clients get the best value for their money."

Our manufacturing unit built in 18000 sq. feet area with technologically upgraded to meet the different requirements of the clients. With a state of the art manufacturing unit, we are committed to achieve the set targets. We have separate sections for the different production processes like Fabrication, Painting, Assembling, Machine shop etc.,

ENGINEERING DESIGN well equipped with ultra-modern CAD/CAM facilities, we are a one-stop-solution provider for different industrial needs. With a team of qualified design engineers, we can design and develop superior quality Centrifugal Air Blowers & Fans. Our teams of designers are capable of manufacturing products according to the specifications of the clients. Understanding the requirements of different industries, we design equipment that ensure best performance and yield maximum advantage to the clients.

## Why choose us?

- High energy efficiency
- Cost effective
- Reduce noise
- High manufacturing quality
- Precise flow and pressure
- Excellent after sales service and support
- ID and FD Fans manufacturers
- Centrifugal Blowers for all industries
- DWDI Centrifugal Blowers and Fans for HVAC and Air Washer Units

## Industries Served

- Foundry
- Pharma
- Iron/steel
- Textile
- Boiler
- Gasifier Plant
- Plastics
- Furnaces
- Cotton/Ginning
- Paper Mill
- Plywood mfg.
- Coal
- Cement
- Chemical
- Food
- Ceramics

# Our Products

## CENTRIFUGAL BLOWERS

We have developed a series of Blowers for almost all the industrial requirements. Centrifugal Blowers designed and supplied by us are proven, efficient, reliable, smooth and sturdy. These are categorized by their pressure generation capacities & Drive types.

Centrifugal Industrial Blowers can be considered as the heart of any processing industry. It is known as many types like ID Fan, FD Fan, Industrial Blower, High Pressure Fan, Hot Air Circulation fan according to application.

We Supply following types of impellers bases on application requirement.

- Radial Blade
- Backward Curved / Backward Inclined
- Forward Curved
- Airfoil Blades

**We Supply following types of Blowers bases on application requirement : -**

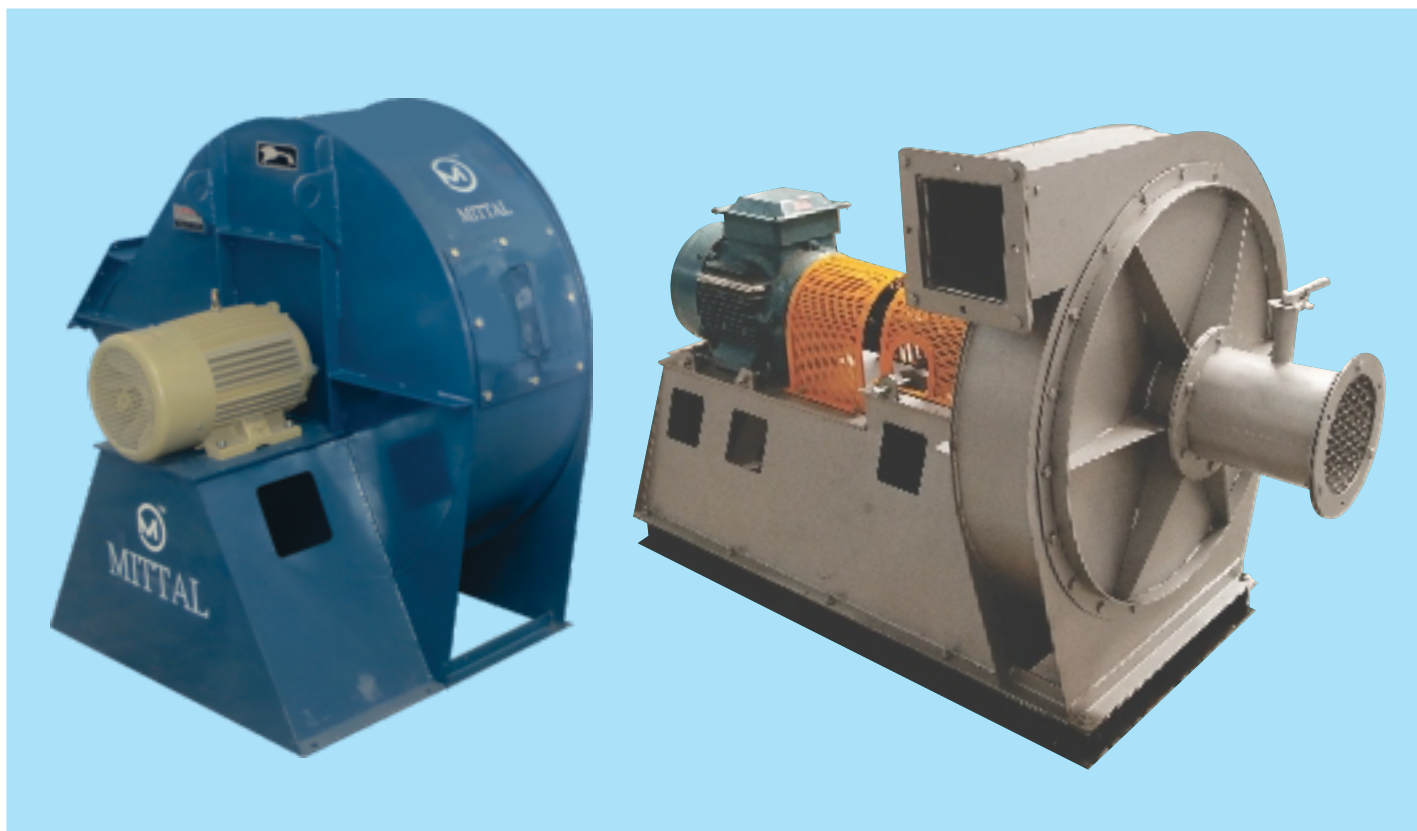



## LOW PRESSURE BLOWER

### Generally used as ventilation fans / gas exhaust fans

Single or double inlet types fans are very efficient and useful for fresh air supply, ventilation. Impellers are backward curved and forward curved type. Fans are generally used for clean air duty.

### Operating Range:

- Air flow (Capacity) : 300 CMH to 250000 CMH
- Motor up to 225 kW
- Static pressure range : 20mm to 150 mm
- Construction materials of Casing: Mild Steel and Stainless Steel
- Max RPM range : 300 RPM to 1450 RPM
- Low noise level
- Construction materials of Impeller: Mild Steel and Stainless Steel

### Applications:

Low pressure blower is used if the focus is on high air flow and very low pressure. Low pressure blower for industrial applications generates pressures up to 150 mmWC.



## MEDIUM PRESSURE BLOWERS

### Generally used as exhausters.

These are employed for air containing dust or particles, fiber, flakes and having higher temperatures than ambient. Usually offered in single inlet types fans are moderately efficient and useful for creating draft in systems. Impellers are Radial Blade or backward inclined or curved blade type having flat or Airfoil designs, with Shrouded or open constructions. Split housings facilitate wheel removal without disturbing connecting ductwork.

### Operating Range:

- Air flow (Capacity) : 300 CMH to 200000 CMH
- Motor up to 200 kW
- Static Pressure Range : 150 mm to 650 mm
- Construction materials of Casing: Mild Steel and Stainless Steel
- Max RPM range : 800 RPM to 3000 RPM
- Construction materials of Impeller: Mild Steel and Stainless Steel

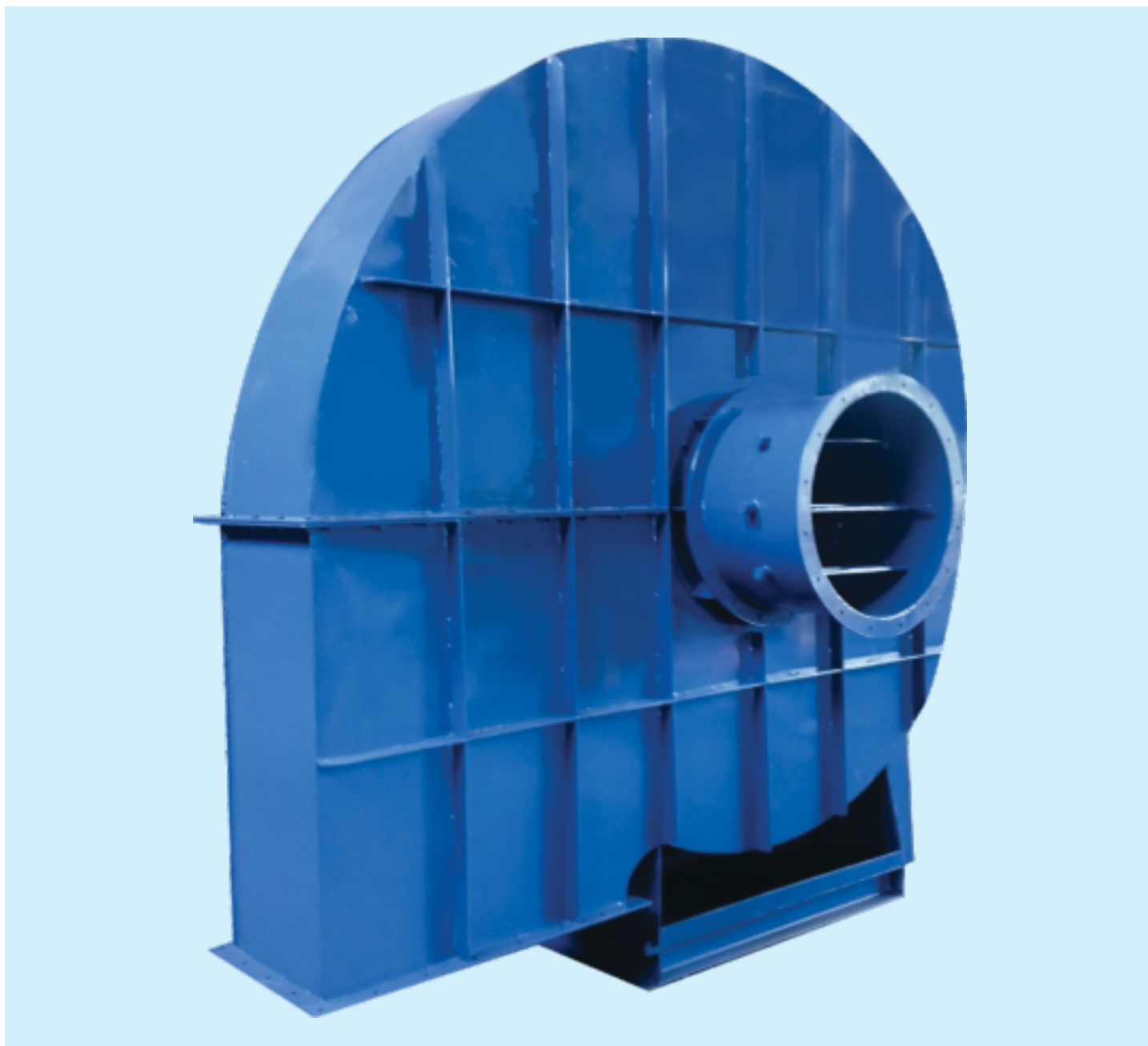

## HIGH PRESSURE AIR FANS

Generally used for combustion and very high Resistance Operating Range

- Air flow (capacity) range: 400 CMH to 100000 CMH
- Static Pressure Range: 700 mm to 2000 mm
- Max RPM range : 800 RPM to 2900 RPM
- Motor up to 250 kW
- Material of Construction : Mild Steel and Stainless Steel

## PLUG FAN

Backward-inclined centrifugal wheels are designed to provide efficient and reliable operation for commercial and industrial applications. They are suitable for supply, exhaust, or recirculation systems. In most instances, plug fans are unshoused and rely on the plenum space around the wheel to direct airflow as required in the system. This style of fan is designed with the motor, bearings, and drives out of the airstream, which allows for use in clean, contaminated or high temperature systems.

### Operating Range

- Volumetric flow capacity up to 1,50,000 m<sup>3</sup> /hr
- Maximum pressures of 150 mmWC
- Maximum operating temperature of 300°C
- Belt or direct drive

### Typical Applications

- Heating and air conditioning systems
- High temperature processes such as ovens, dryers and kilns
- Spray booth evaporators and textile dust collectors

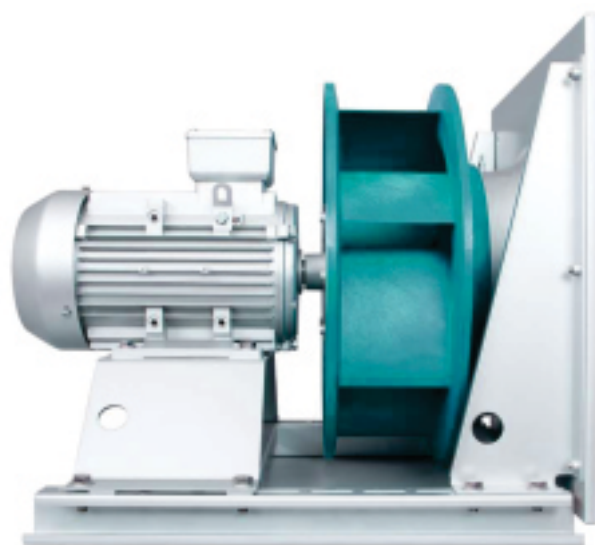
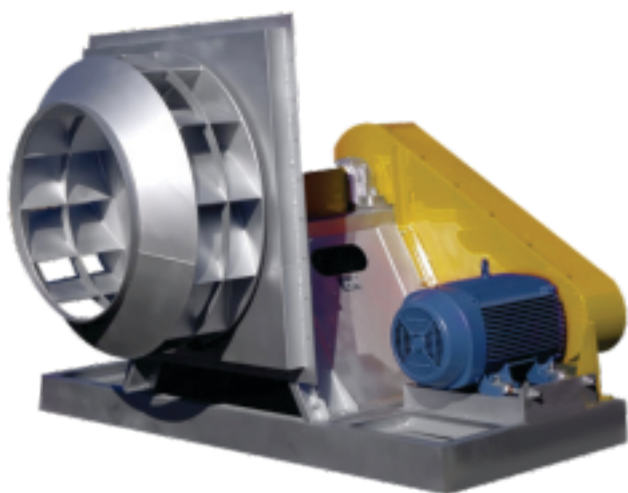

## SQI CENTRIFUGAL BLOWERS

Typical applications include conveying, induced draft, industrial ovens, and similar high temperature installations 300°C. For greater safety in explosive environments, spark resistant construction is offered. Lint-free construction which housing hardware is reversed to limit obstructions in the airstream, minimizes lint build-up.

### OPERATING RANGE

- Air flow (capacity) range : 100 CMH to 15000 CMH,
- Static Pressure Range : 150 mmWC to 500 mmWC,
- RPM variation : 1450 - 3000,
- Motor KW : up to 25 KW,
- Material of Construction : Mild Steel and Stainless Steel

### TYPICAL APPLICATIONS

- Material conveying
- Dust collection
- Oven exhaust
- Dryer exhaust
- Paper trim transport





## DWDI – DOUBLE WIDTH, DOUBLE INLET

DWDI fans are generally supplied for V-belt drive and Coupling Drive. The wheel is mounted between the bearings and supported by the fan housing. Since both bearings are located in the airstream, standard DWDI fans should be used for clean air applications with air temperatures limited to 130°F. The motor can be mounted in any of the four standard motor

**Positions: W, X, Y or Z.**

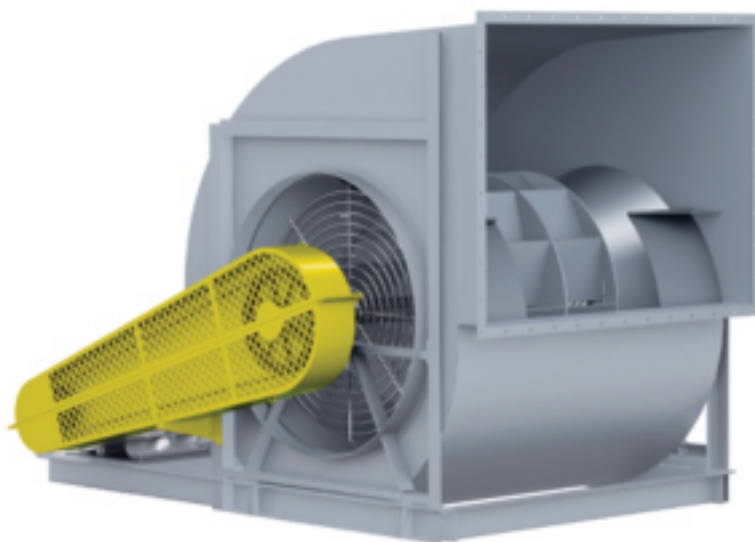

## PP-FRP or MS-FRP BLOWERS

PP-FRP Blowers are mostly used to resist weathering, corrosive fumes and gases etc. They are specially designed for laboratory Ventilation, laboratories to handle highly corrosive gases and fumes. They have been proven suitable for pickling plants and other refining processes, electroplating and pharmaceutical chemical industries etc. The fans are also available as per the client requirement. They are available in Direct or V- belt drive types. MS-FRP Centrifugal Blowers in capacity range from 500 CMH to 6000 CMH and static heads ranging from 50 mm to 750 mm water column. Our range of pollution control equipments are centrifugal Blowers, Wet Scrubbers, Fume extraction systems, Venturing Scrubbers, fume stacks etc. Material of Construction: PPFRR, HDPEFRP, PP Blowers.



## Flange Mounted Blower



## INLINE FAN

Inline fans, centrifugal duct fans are the ideal air movers for residential, commercial and industrial applications. The quiet and efficient airfoil impeller is capable of developing significant pressure and the inline configuration simplifies installation. The unique motor design, combined with high quality materials and workmanship, results in a truly versatile fan. The in-line configuration of these fans simplifies installation. We also offer these fans as per the customized designs provided by the clients.



## TYPES OF IMPELLER



Forward Curved

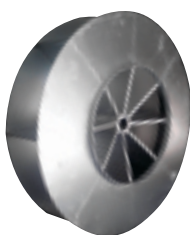

Radial Blade



Backward Inclined



Backward Curved



Airfoil



Paddle Open Blade

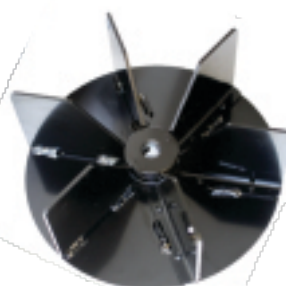

Open Radial Blade



DWDI Impeller

## ACCESSORIES OF CENTRIFUGAL AIR BLOWERS

### Expansion Bellow

In air ductwork systems, dynamic stresses caused by fan vibrations, temperature fluctuations and other sources can lead to premature equipment failure. Flex duct connectors or expansion joints provide flexibility along duct when connected to rotating equipment to alleviate these stresses

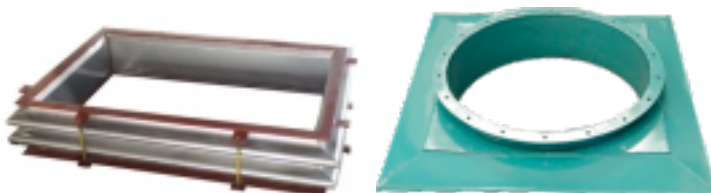

### Suction Filter

In dust laden areas, inlet filters are recommended so that the fan can suck clean air and discharge at elevated pressure. This will prevent undue clogging of various devices connected in the up-stream of the fan and reduce maintenance.

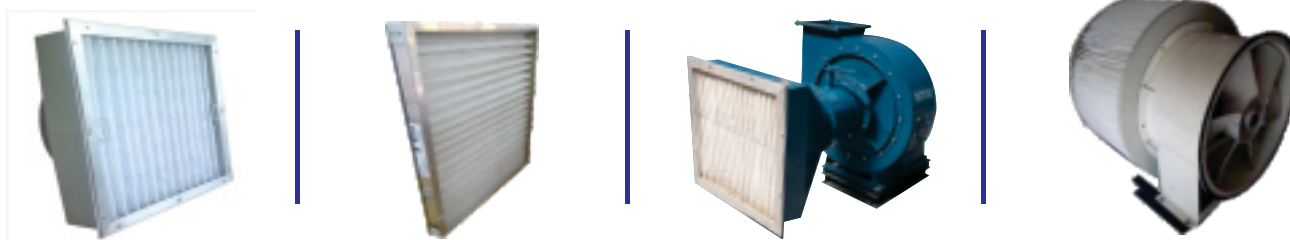

### Silencer

Silencers can be provided to reduce the noise level of the blower. We design and manufacture silencer with inlet filter as per discharge of the fan.



## Damper

Multi-vane damper fitted at the inlet of the fan are used for smooth start up of the fan and pressure control during normal operation. These come with manual and automatic version in various diameters for different capacities.



## Vibration Isolator

In order to reduce the vibration level at site the fan can be supplied with vibration isolator.



## Pulley

Different size of pulley to achieve different rotational speeds are available. Simple and taper lock pulleys are available in different grooves.



**Pulley**



**Taper Lock Pulley**



**Taper Lock Pulley Bush**

## Coupling

**Pin Bush**



**Grid Coupling**



**Tyre Coupling**



## Pedestal

Different sizes of composite Pedestal as well as Plummer blocks are available as per load and requirement of blowers.



**Composite Assembly**



**Plummer block Assembly**

## Shaft Cooler (Heat Slinger)

Cast aluminum shaft cooler dissipates the heat transferred to the shaft from the airstream protecting the fan bearings.

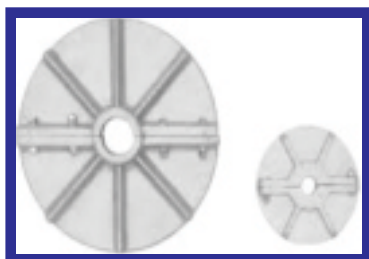

**Cooling disk**











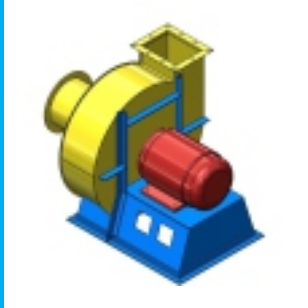

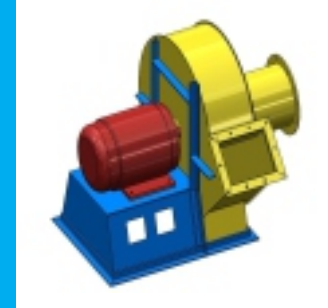

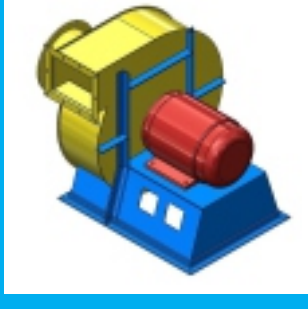

**Shaft Cooler**

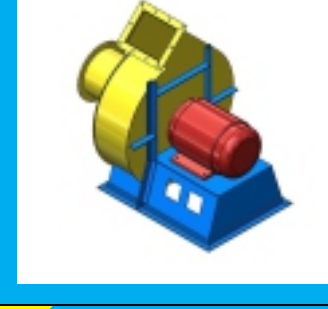

**Stuffing Box**

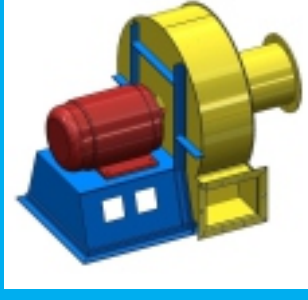
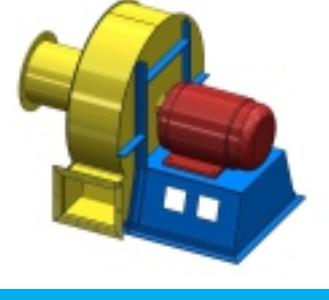
## BLOWER DISCHARGE POSITION CHART

<b>A</b> DRIVE SIDE ANTI CLOCK WISE TOP VERTICLE-360 	<b>E</b> DRIVE SIDE CLOCKWISE TOP VERTICLE-360 	<b>I</b> DRIVE SIDE ANTI CLOCK WISE BOTOM ANGULAR UP-315 	<b>M</b> DRIVE SIDE CLOCKWISE BOTOM ANGULAR UP-315 
<b>B</b> DRIVE SIDE ANTI CLOCK WISE TOP HORIZONTAL-90 	<b>F</b> DRIVE SIDE CLOCKWISE TOP HORIZONTAL-90 	<b>J</b> DRIVE SIDE ANTI CLOCK WISE TOP ANGULAR DOWN-135 	<b>N</b> DRIVE SIDE CLOCKWISE TOP ANGULAR DOWN-135 
<b>C</b> DRIVE SIDE ANTI CLOCK WISE DOWN BLAST-180 	<b>G</b> DRIVE SIDE CLOCKWISE DOWN BLAST-180 	<b>K</b> DRIVE SIDE ANTI CLOCK WISE TOP ANGULAR UP-45 	<b>O</b> DRIVE SIDE CLOCKWISE TOP ANGULAR UP-45 
<b>D</b> DRIVE SIDE ANTI CLOCK WISE BOTTOM HORIZONTAL 270 	<b>H</b> DRIVE SIDE CLOCKWISE BOTTOM HORIZONTAL 270 	<b>L</b> DRIVE SIDE ANTI CLOCK WISE BOTTOM ANGULAR DOWN 225 	<b>P</b> DRIVE SIDE CLOCKWISE BOTTOM ANGULAR DOWN 225 

## Motor Mounting Position as Standards

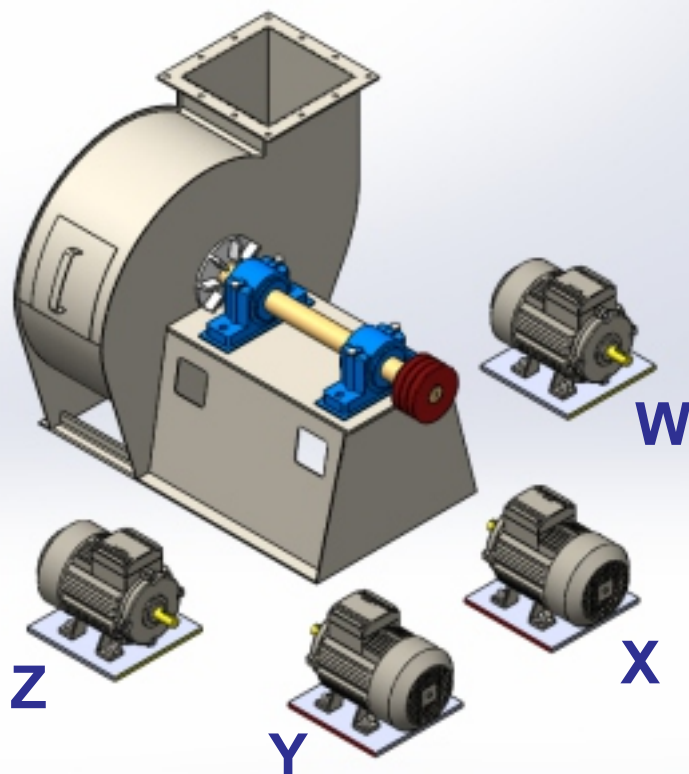

**CENTRIFUGAL FANS ARE RECOMMENDED BY DRIVE TYPE ARRANGEMENTS.**

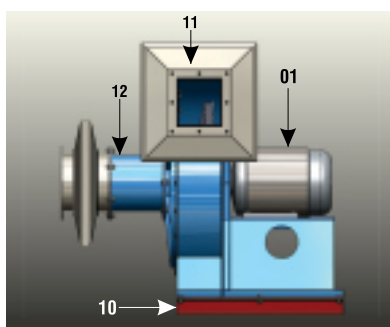

**1. DIRECT DRIVE**

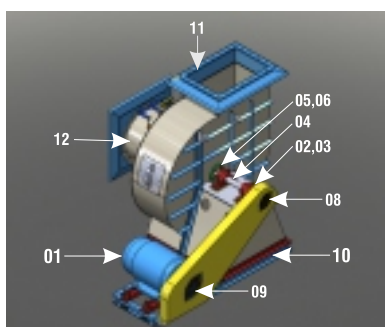

**2. V-BELT DRIVE**

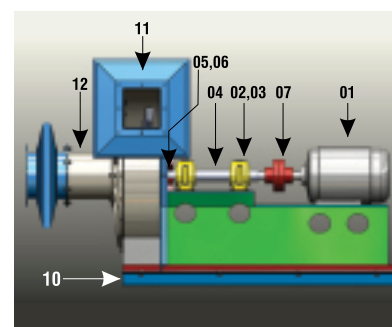

**3. COUPLE DRIVE**

### TERMINOLOGY FOR 'MITTAL' FAN PARTS / ACCESSORIES

SR. NO	PART NO.	ACCESSORY	SR. NO.	PART NO.	ACCESSORY
01	01	DRIVE MOTOR	07	07	FLEXIBLE COUPLING
02	02	BEARINGS	08	08	FAN PULLEY
03	03	BEARING BLOCK	09	09	MOTOR PULLEY
04	04	DRIVE SHAFT	10	10	VIBRATION ISOLATORS
05	05	HEAT SLINGER/COOLING DISK	11	11	EXPANSION BELLOW
06	06	GLAND SEAL	12	12	DAMPER

# AXIAL FANS

## AXIAL FLOW FANS, BIFURCATED FANS, MAN COOLER FAN, PRODUCT COOLING FAN, WALL MOUNT FAN

We Provide effective air supply or exhaust through a ducted system requiring high static pressure. Can be connected to a Hood and Duct System for effective remote exhaust or filtered ventilation air supply systems.

### Features

- Duct fans in series for tunnel ventilation requiring static pressure up to 7-8" mmWC.
- Different blades combination for low noise at higher RPM.
- Being electrically connected-Ready to start
- Sweep Diameter Range: 310 mm to 1200 mm (12" to 48")
- Airflow Range : 1000 to 40000 CFM
- Static Pressure Range : 0 to 75 mmWC (0" to 3" mmWC)
- Motor Rating Range : 0.5 HP to 20 HP
- Drive : Direct / V-belt
- MOC : Mild Steel and Stainless Steel
- RPM : 720 to 1440 RPM

### Construction:

Complete with heavy casing tube, Motor base, Impellers-Fabricated MS/Al or Cast Aluminum blades.

### Impeller Balancing:

Statically & dynamically balanced to ISO G6.3

### Mounting Option:

Cooling Axial Fan, Tube Axial Fan (Standing, Wall Mounting, Roof Mounting), Bifurcated Axial Fan (Standing, Wall Mounting), Customized Axial Fan (Couple Driven, V-Belt Driven)



Wall Mounted /Man cooler Fan



Axial Fan Direct Drive



Tube Axial Fan Direct Drive



Pedestal Man Cooler Fan



Bifurcated Fan



Square Fan



Tube Axial Fan



Tube Axial Fan



# BLOWER GALLERY

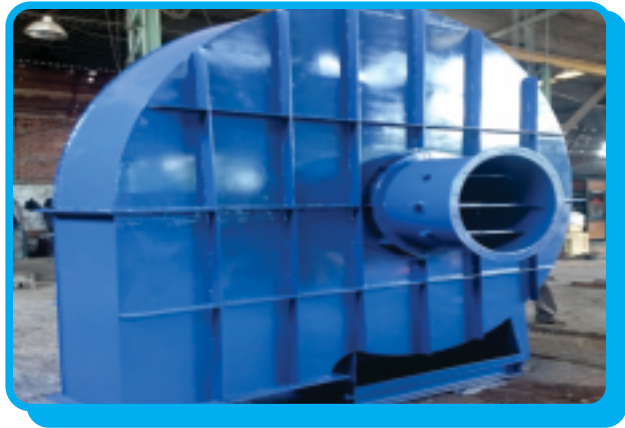

# BLOWER GALLERY



# BLOWER GALLERY





## **MITTAL BLOWERS INDIA PVT. LTD.**

MFG. CENTRIFUGAL BLOWERS / FANS & AIR POLLUTION CONTROL EQUIPMENTS  
Plot No.: C/17 Krishna Industrial Park-2, Nr. Royal Galaxy Industrial Park, Opp. Lake,  
Shivbhumi Estate Road, Ta: Daskroi, Kubadthal -382430.

**Contact No.:** 9904279942

E-mail Id.: [mittalfab@gmail.com](mailto:mittalfab@gmail.com), [sales@mittalblowers.com](mailto:sales@mittalblowers.com), [info@mittalblowers.com](mailto:info@mittalblowers.com)

ISO 9001 : 2015 Certified COMPANY